



COLOUR TELEVISION

MODEL WITH THE TELETEXT FUNCTION

AV-14FMT4

AV-21CMT4

AV-21DMT4

AV-21YMT4

MODEL WITHOUT THE TELETEXT FUNCTION

AV-14AG14

AV-14AMG4

AV-14FMG4

AV-14FMG4B

AV-20NMG4

AV-21CG14

AV-21CMG4

AV-21DMG4

AV-21FMG4B

AV-21LMG4

AV-21TG14

AV-21TMG4

AV-21YMG4

Contents

Knowing your TV's features	2
Remote control buttons and basic functions .	3
TV buttons and functions	5
Setting up your TV	6
Basic setting for picture	8
Advanced setting for picture	9
Original features for picture	9
Basic setting for sound	10
Advanced setting for sound	10
Favorite channel and video setting	11
Customized setting	12
TV channel presetting	13
Additional preparation	15
Troubleshooting	15
Specifications	Back cover

INSTRUCTIONS

Thank you for buying this JVC colour television.

To make sure you understand how to use your new TV, please read this manual thoroughly before you begin.

Safety Instructions

WARNING: TO PREVENT FIRE OR SHOCK HAZARD, DO NOT EXPOSE THIS APPLIANCE TO RAIN OR MOISTURE.

CAUTION: TO ENSURE PERSONAL SAFETY, OBSERVE THE FOLLOWING RULES REGARDING THE USE OF THIS TV.

- 1 Operate only from the power source indicated on the rear of the TV.
- 2 Avoid damaging the power cord and mains plug. When unplugging the TV, grasp the mains plug. Do not pull on the power cord.
- 3 Never block or cover the cabinet ventilation openings. Never install the TV where good ventilation is unattainable. When installing this TV, leave spaces for ventilation around the TV more than the minimum distances as shown in the diagram.

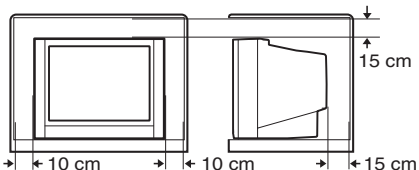

- 4 Do not allow objects or liquid into the cabinet openings.
- 5 In the event of a fault, unplug the unit and call a JVC service technician. Do not attempt to repair it yourself or remove the rear cover.
- 6 The surface of the TV screen is easily damaged. Be very careful with it when handling the TV. Should the TV screen become soiled, wipe it with a soft dry cloth. Never rub it forcefully. Never use any cleaner or detergent on it.
- 7 If you are not going to use this TV for a long period of time, be sure to disconnect the AC plug from the AC socket.
- 8 The apparatus shall not be exposed to dripping or splashing and that no objects filled with liquids, such as vases, shall be placed on the apparatus.

Knowing your TV's functions

Main features

Function	Description
*Teletext	You can view teletext programmes which are broadcasted by some TV channels. Teletext programme is an information in text form.
Favorite CH (Channel)	You can register up to four favorite channels for quick re-call with one-press.
AI Volume	TV adjusts automatically the volume to the same level for all TV channels to avoid sudden change of the volume when selecting different TV channel.
VNR	You can reduce the picture noise when you viewing noisy TV programmes or video sources.
White balance	You can choose one of three tones of white to match to the video source such as movie, sports, etc. Changing White balance affects the appearance of all other colours on the screen.
Child lock	To prevent accidental operation by your children, you can disable the control buttons on the TV.

* The Teletext function is available for AV-14FMT4, AV-21CMT4, AV-21DMT4 and AV-21YMT4 only.
The other models do not have the Teletext function. Please check your TV's model number. The model number is indicated at the rear of your TV.

Remote control buttons and basic functions

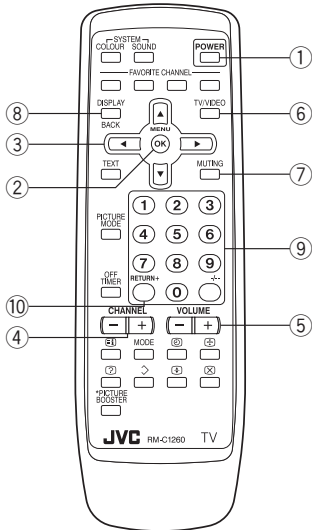

RM-C1260
WITH THE TELETEXT
FUNCTION
(AV-14FMT4/AV-21CMT4/
AV-21DMT4/AV-21YMT4)

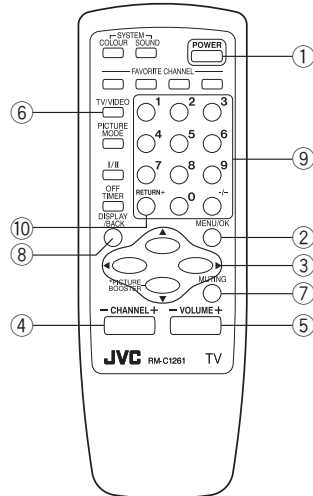

RM-C1261
WITHOUT THE TELETEXT
FUNCTION
(AV-14AG14/AV-14AMG4/
AV-14FMG4/AV-14FMG4B/
AV-20NMG4/AV-21CG14/
AV-21CMG4/AV-21DMG4/
AV-21FMG4B/AV-21LMG4/
AV-21TG14/AV-21TMG4/
AV-21YMG4)

No. Press	To
① POWER	Turn on or off the TV from standby mode.
② MENU/OK	Display menu and confirm selected function.
③ ▲/▼/◀/▶	Select and adjust menu function.
④ CHANNEL -/+	Select the desired channel number.
⑤ VOLUME -/+	Adjust the volume level.
⑥ TV/VIDEO	Select TV or VIDEO terminal input.
⑦ MUTING	Turn off the volume. Press this button again to resume the volume.
⑧ DISPLAY /BACK	Display the programme number or video terminal number and PR list (channel list) on the screen. You can select the channel using the PR list. 1 Press the DISPLAY button once to display the PR list. 2 Press ▲/▼/◀/▶ button to choose a channel, then press the MENU/OK button. You can confirm the favorite channels in the PR list. The channels set to favorite channels are indicated with coloured mark. On the other hand, you can use this button to return to the previous menu.
⑨ 0-9, -/--	Select the programme number. For two digits programme number, press -/--, then press the number button.
⑩ RETURN+	a) Return to the frequently view channel with one touch. 1 Choose the channel you want to register. 2 Press and hold RETURN+ button until "RETURN PLUS PROGRAMMED!" appears. To cancel, press and hold RETURN+ button until "RETURN PLUS CANCELED!" appears. b) Return to the previously viewed channel, if you have not set or have cancelled the Return channel as above.

Remote control buttons and basic functions

How to operate menus and menu locations

TO	Operation	Note
Display the MENU.	Press the MENU/OK button ②.	To exit the MENU, press the DISPLAY/BACK button* ⑧ or choose EXIT menu.
Display the top menu.	Press ▲/▼ buttons ③ to choose a menu title. Then press MENU/OK button ②.	Press ▼ button ③ to display the next page for more functions.
Display the 2nd menu.	Press ▲/▼ buttons ③ to choose a menu title. Then press MENU/OK button ②.	
Display the 3rd menu.	Press ▲/▼ buttons ③ to choose a menu title. Then press MENU/OK button ②.	
Return to the previous menu.	Press the DISPLAY/BACK button* ⑧.	-
Choose the setting of a function.	Press ▲/▼ buttons ③ to choose a function. Then press the ◀▶ buttons ③ to change the setting.	Press the MENU/OK button ② to exit from the menu.
Adjust the effect level of a function.	Press ▲/▼ buttons ③ to choose a function. Then press the ◀▶ buttons ③ to adjust the effect level.	
Display the sub menu of a function.	Press ▲/▼ buttons ③ to choose a function. Then press MENU/OK button ② to display the sub menu.	-

The following chart shows locations of functions in menus.

In this manual, location of a function is described as follows:

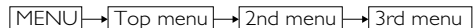

Note: Some functions have the 4th menus as the sub-menus.

* To exit the menu, the on screen display will show BACK indicated in blue. But it doesn't refer to the blue button on the remote control. Instead, it refers to the DISPLAY/BACK button on the remote control.

	Top menu	2nd menu	Location	3rd menu	Location	
MENU	INPUT	EXT. INPUT	P.12	-	-	
		DISPLAY	P.12	-	-	
	* If you want to adjust PICTURE SETTING menu, you must set PICTURE MODE menu to USER.	PICTURE	PICTURE MODE	P.8	-	-
			PICTURE SETTING	P.8	-	-
			WHITE BALANCE	P.8	-	-
			PICTURE FEATURES	-	VNR	P.12
				-	FAVORITE CH SETTING	P.11
	-	VIDEO SETTING		P.11		
	-	COLOUR SYSTEM	P.8			
	-	PICTURE BOOSTER	P.8			
	SOUND	AI VOLUME	P.10	-	-	
	FEATURES	OFF TIMER	P.12	-	-	
		CHILD LOCK	P.12	-	-	
	INSTALL	AUTO PROGRAM	P.13	-	-	
		EDIT/MANUAL	P.13	DELETE, MOVE, MANUAL, INSERT	P.13	
		LANGUAGE	P.12	LANGUAGE	P.12	
		BLUE BACK	P.9	-	-	
AUTO SHUTOFF		P.12	-	-		
	TEXT LANGUAGE	P.9	TEXT LANGUAGE	P.9		
EXIT	-	-	-	-		

TV buttons and functions

The following illustrations are for AV-14FMG4 and AV-21TG14 only, which are used for explanation purpose. Your TV may not look exactly like the illustrated.

Front of the TV

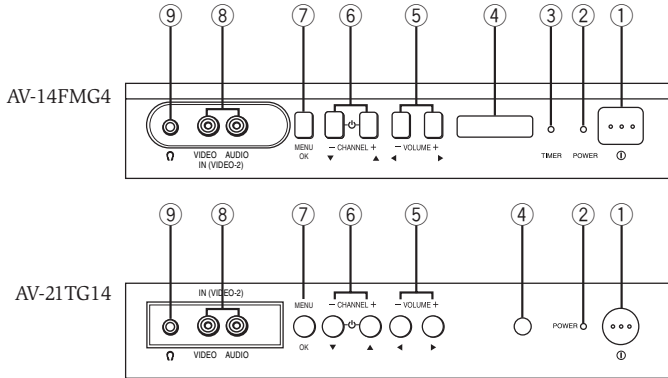

Rear of the TV

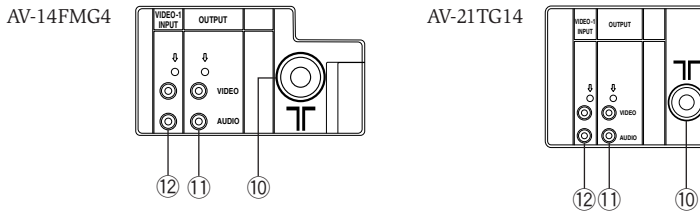

No. Button/terminal	Description
① ① (main power)	Press to turn on or turn off the TV's main power.
② Power lamp	Indicate the TV is being turned on or off. No colour : TV's main power is being turned off. Red : TV's main power is being turned on.
③ TIMER lamp	Lights when the TV is in the OFF TIMER mode.
④ Remote control sensor	
⑤ VOLUME -/+	Press to adjust the volume level.
⑥ CHANNEL -/+	Press to select the desired channel.
⑦ MENU	Press to display the menu.
⑧ IN (VIDEO-2)	Video and audio input jacks for VIDEO-2 mode.
⑨ Ω	Headphone jack.
⑩ T	Aerial socket.
⑪ OUTPUT	Video and audio output jacks.
⑫ VIDEO-1 INPUT	Video and audio input jacks for VIDEO-1 mode.

How to operate the menus with the TV button

TV button	Work as same as the button on the remote control unit	Note
MENU	MENU/OK button	To display main menu and exit menu after finish setting.
CHANNEL -/+	▼/▲ button	To select menu function.
VOLUME -/+	◀▶ button	To adjust the desired function.

Setting up your TV

CAUTION

- Turn off the equipment including the TV before connecting.

1 Connecting the aerial

To install rod aerial

Install into the top-rear aerial holder. Once installed, it cannot be removed.

* For model 14" series only

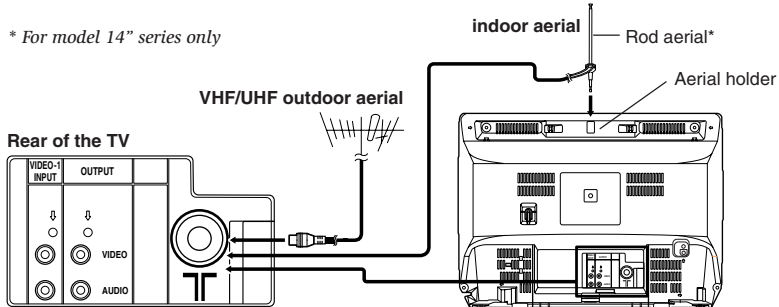

If you connect a VCR, connect the aerial output jack of your VCR and the aerial jack on the TV with the aerial cable. Then connect the output jacks of your VCR and the VIDEO-1 input jacks of the TV with the video cable and audio cables. For details, see the manual of your VCR.

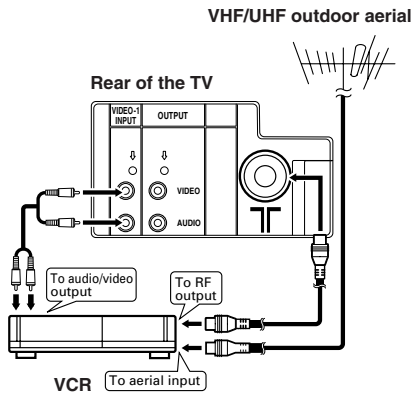

The illustration shown is just a sample. It may not be same as your TV.

2 Connecting the compatible main plug to the AC outlet.

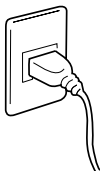

3 Inserting batteries into the remote control.

Insert two batteries by following the \oplus and \ominus polarities and inserting the \ominus end first.

CAUTION:

Follow the cautions printed on the batteries.

Notes:

- Use AA/R6/UM-3 dry cell batteries.
- If the remote control does not work properly, fit new batteries. The supplied batteries are for testing, not regular use.

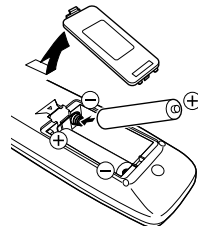

4 Turn on the TV by pressing the main power button.

JVC logo appears on the screen.

Setting up your TV (continued)

5 Making the initial settings

Set up your TV by pressing MENU/OK button or waiting for 15 seconds, then operate the TV by following the steps as below:



- Press ▲/▼ button to select your desired language.

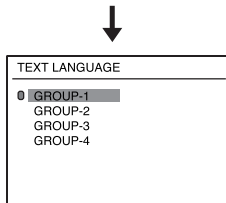

- Press ▲/▼ button to select your desired Teletext language group. For details, see page 9. (For AV-14FMT4/AV-21CMT4/AV-21DMT4/AV-21YMT4 only)

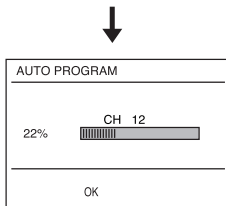

- TV will start searching for the channels. To stop AUTO PROGRAM, press MENU/OK button.

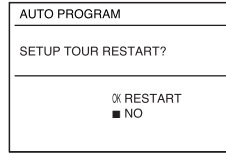

- Press the red button to cancel the SETUP TOUR RESTART function. If you want to make initial settings again when the next time you turn on the TV, press the MENU/OK button to activate the SETUP TOUR RESTART function.

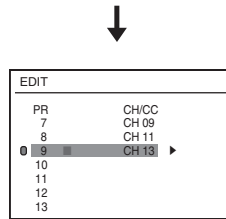

- Proceed to edit the channel list (PR list). For details, see page 13.

- If the JVC logo does not appear, use LANGUAGE, TEXT LANGUAGE, and AUTO PROGRAM functions to make the initial settings. Those functions are located in the INSTALL menu.
- If the JVC logo appears, although you had made the initial settings, press the TV/VIDEO button to exit from initial settings.

Basic setting for picture

COLOUR SYSTEM

You can select the appropriate colour system when the picture is not clear or no colour appears.

Press the COLOUR SYSTEM button to select a setting.

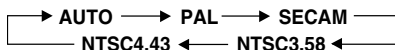

To operate this function with a menu:

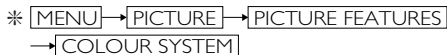

For the colour system in each country or region, see the table below:

Area	Country or Region	System
Asia, Middle East	Bahrain, Kuwait, Oman, Qatar, United Arab Emirates, Yemen, etc.	PAL
	Indonesia, Malaysia, Singapore, Thailand, India, etc.	
	China, Vietnam, etc.	PAL
	Hong Kong, etc.	PAL
	Islamic Republic of Iran, Lebanon, Saudi Arabia, etc.	SECAM
Europe	Philippines, Taiwan, Myanmar, etc.	NTSC
	Russia, etc.	SECAM
	Czech Republic, Poland, etc.	PAL
	Germany, Holland, Belgium, etc.	PAL
Oceania	UK, etc.	PAL
	Australia, New Zealand, etc.	PAL
Africa	Republic of South Africa, etc.	PAL
	Nigeria, etc.	PAL
	Egypt, Morocco, etc.	SECAM

PICTURE MODE

You can choose the desired picture setting with one-touch.

Press the PICTURE MODE button to select a setting.

SOFT	Softens contrast and sharpness.
BRIGHT	Heightens contrast and sharpness.
STANDARD	Standard picture setting.
USER	You can change this picture setting as you like. Select USER and adjust following items in the PICTURE SETTING menu. (CONTRAST, BRIGHT, SHARP, COLOUR, TINT*)

*TINT can only be adjusted in NTSC system.

To operate this function with a menu:



To return the USER setting to the default, press the blue button when the PICTURE SETTING menu appears.

Adjusting the picture - USER

You can adjust the desired picture setting when selecting USER in PICTURE MODE.

1 Select the USER in PICTURE MODE under PICTURE menu.



2 Select the PICTURE SETTING in PICTURE menu, then adjust the setting.



CONTRAST	◀ : Lower contrast	▶ : Higher contrast
BRIGHT	◀ : Darker	▶ : Brighter
SHARP	◀ : Softer	▶ : Higher
COLOUR	◀ : Lighter	▶ : Deeper
TINT*	◀ : Reddish	▶ : Greenish

*TINT can only be adjusted in NTSC system.

PICTURE BOOSTER

(AV-21YMG4/AV-21YMT4 only)

You can improve picture clarity when the picture is unclear due to the low signal reception. Press the PICTURE BOOSTER button to select the desired mode.

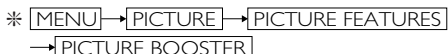

HIGH	Perform at maximum level.
LOW	Perform at minimum level.
OFF	Cancel the function.

WHITE BALANCE

You can change the white balance of the picture to better match the type of video being viewed. Select the WHITE BALANCE in the PICTURE menu, then choose the desired setting.



NORMAL	Normal white balance.
COOL	Bluish white.
WARM	Reddish white.

* About the basic operations of the menu, please see the "How to operate menus and menus locations" on page 4.

Advance setting for picture

BLUE BACK

You can set the TV to automatically change to a blue screen and mute the sound if the signal is weak or absent, or when there is no input from an antenna.

Select the BLUE BACK in the INSTALL menu, then choose ON or OFF.

※ [MENU] → [INSTALL] → [BLUE BACK]

If you wish to continue viewing the poor picture, cancel the BLUE BACK function.

Original features for picture

TELETEXT

You can watch the Teletext broadcast channel with TEXT function.

- 1 Press the TEXT button to select the desired mode as follows:

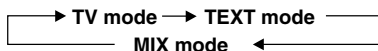

- 2 Press the CHANNEL +/- buttons, number buttons or colour buttons to select other Teletext pages.
- 3 Press TEXT or TV/VIDEO button to return to TV mode.

You can also operate the teletext using the following buttons:

(Hold)	Hold a teletext page. The (Hold) are displayed at the top left of the screen. To cancel, press (Hold) button again.
(Reveal)	Display the hidden text (e.g. answers to a quiz). To cancel, press (Reveal) button again.
(Size)	Enlarge the teletext display.
(Index)	Return to the index page instantly.
(Cancel)	Watch TV programme while waiting for a teletext page. When the teletext page is found, a page number appears at the upper left of the screen. Press (Cancel) to view the teletext page.
(Sub-page)	Operate the (Sub-page) function. Sub-page numbers are displayed at the left of the screen. To cancel sub-page function, press (Sub-page) button again.

Using the List mode

You can store and recall the favorite teletext pages in memory using the colour buttons.

- 1 In TEXT mode, press the MODE button to enter the List mode.

- 2 Press a colour button, then press the number buttons to enter the page number.

- 3 Press and hold down the (Store) button. The page number is blinking white to indicate that they are stored in memory.

- 4 To store other favorite teletext pages, repeat Step 2 to 3.

To recall the favorite teletext page, press the MODE button, then press the colour button. To exit the List mode, press the MODE button again.

When viewing teletext programme, menu operations are not available.

If characters on a teletext programme do not appear properly, change the TEXT LANGUAGE setting.

TEXT LANGUAGE

You can set the Teletext language group that corresponds to the programmes.

Select TEXT LANGUAGE in the INSTALL menu, then choose the desired language group.

※ [MENU] → [INSTALL] → [TEXT LANGUAGE]

GROUP- 1	English, German, Swedish / Finnish / Danish / Hungarian, Italian, French, Spanish / Portuguese, Turkish
GROUP- 2	Polish, German, Estonian, Slovenian, Czech / Slovakian, Rumanian
GROUP- 3	Polish, German, Estonian, Lettish, Russian, Ukrainian
GROUP- 4	English, French, Turkish, Arabic, Iranian

Depending on the broadcast, the language set may not display properly.

※ About the basic operations of the menu, please see the “How to operate menus and menus locations” on page 4.

Basic setting for sound

SOUND SYSTEM

You can select an appropriate sound system when abnormal sound occurs even when the picture appears normally.

Press the SOUND SYSTEM button to select a setting.

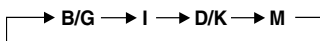

The function is not available in video mode.
For the sound system in each country or region, see the table below:

Area	Country or Region	System
Asia, Middle East	Bahrain, Kuwait, Oman, Qatar, United Arab Emirates, Yemen, etc. Indonesia, Malaysia, Singapore, Thailand, India, etc.	B/G
	China, Vietnam, etc.	D/K
	Hong Kong, etc.	I
	Islamic Republic of Iran, Lebanon, Saudi Arabia, etc.	B/G
	Philippines, Taiwan, Myanmar, etc.	M
Europe	Russia, etc.	D/K
	Czech Republic, Poland, etc.	D/K
	Germany, Holland, Belgium, etc.	B/G
	UK, etc.	I
Oceania	Australia, New Zealand, etc.	B/G
Africa	Republic of South Africa, etc.	I
	Nigeria, etc.	B/G
	Egypt, Morocco, etc.	B/G

Advanced setting for sound

AI VOLUME

You can adjust the volume of all the channels and video inputs to the same level automatically. Select the AI VOLUME in SOUND menu, then choose ON or OFF.

* [MENU] → [SOUND] → [AI VOLUME]

* About the basic operations of the menu, please see the “How to operate menus and menu locations” on page 4.

Favorite channel and video setting

To register the favorite channel

You can register and recall 4 favorite channels by using the colour buttons (red, green, yellow, blue).

- 1 In TV mode, select a TV channel (PR01- 99) you desired to register.
- 2 Press and hold a colour button for 3 seconds or more. "FAVORITE CHANNEL ■ PROGRAMMED!" appears on the screen and current channel is registered.
- 3 To register other favorite channels, repeat Step 1 to 2.

To recall the favorite channel, press the colour button.

When the TV is in Text mode or menu mode, favorite channel function is not available.

To adjust favorite channel setting (FAVORITE CH SETTING)

You can adjust the picture settings for the favorite channels.

- 1 Display the PICTURE menu and select FAVORITE CH SETTING in PICTURE FEATURES menu.



- 2 Select FAVORITE CHANNEL in FAVORITE CH SETTING menu, then choose the desired favorite channel.

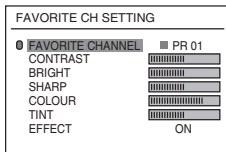

- 3 Select EFFECT, then press ◀/▶ button to choose ON. To cancel the settings, choose OFF.
- 4 Select the desired item that you wish to adjust.

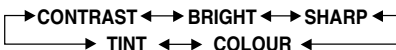

- 5 Press the MENU/OK button to exit the menu.

To adjust the video setting (VIDEO SETTING)

You can adjust the picture settings for video inputs.

- 1 Display the PICTURE menu and select VIDEO SETTING in PICTURE FEATURES menu.

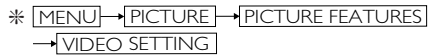

- 2 Select VIDEO STATUS in VIDEO SETTING menu, then choose the desired video input.

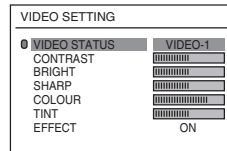
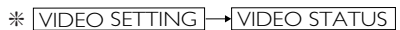

- 3 Select EFFECT, then press ◀/▶ button to choose ON. To cancel the settings, choose OFF.

- 4 Select the desired item that you wish to adjust.

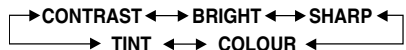

- 5 Press the MENU/OK button to exit the menu.

* About the basic operations of the menu, please see the "How to operate menus and menus locations" on page 4.

Customized setting

VNR

You can reduce the noise.

Select the VNR in the PICTURE FEATURES menu under PICTURE menu, then choose a setting of VNR function.

* [MENU] → [PICTURE] → [PICTURE FEATURES]
→ [VNR]

OFF	VNR is turned off.
AUTO	Effect of VNR is automatically controlled.
MIN	Effect of VNR becomes minimum level.
MAX	Effect of VNR becomes maximum level.

If you select MAX, the picture becomes softer even if the original picture is sharp.

LANGUAGE

You can choose your desired on screen display language.

Select the LANGUAGE in the INSTALL menu, then choose a language.

* [MENU] → [INSTALL] → [LANGUAGE]

CHILD LOCK

You can disable the front control buttons of the TV.

Select the CHILD LOCK in the FEATURES menu, then choose ON or OFF.

* [MENU] → [FEATURES] → [CHILD LOCK]

OFF TIMER

You can set the TV to turn off automatically to standby mode after a set time.

Press the OFF TIMER button to select a desired period of time.

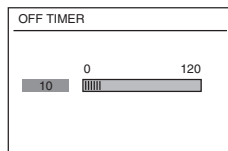

You can set the period of time to a maximum of 120 minutes in 10 minutes step.

To operate this function with a menu:

* [MENU] → [FEATURES] → [OFF TIMER]

When the elapsed of time left one minute, "GOOD NIGHT!" appears on the screen.

You can display the OFF TIMER menu again to confirm or change the remaining time.

AUTO SHUTOFF

You can set the TV to turn off automatically when no signal is received for about 15 minutes or longer after the end of a broadcast.

Select AUTO SHUTOFF in INSTALL menu, then choose ON or OFF.

* [MENU] → [INSTALL] → [AUTO SHUTOFF]

The AUTO SHUTOFF function does not turn off the TV's main power.

The AUTO SHUTOFF function is not available in video mode.

EXT. INPUT (TV/ VIDEO)

You can select TV or video terminal input with one touch.

Press the TV/VIDEO button to select an input.

To operate this function with a menu:

* [MENU] → [INPUT] → [EXT.INPUT]

DISPLAY

You can display the programme number, video terminal number and PR list on the screen.

Press the DISPLAY button to display the information on screen.

To operate this function with a menu:

* [MENU] → [INPUT] → [DISPLAY]

* About the basic operations of the menu, please see the "How to operate menus and menus locations" on page 4.

TV channel presetting

To register the TV channels automatically

You can register the TV channels into the TV's channel list automatically.

1 Display the INSTALL menu.

* [MENU] → [INSTALL]

2 Choose AUTO PROGRAM, then press the MENU/OK button.

AUTO PROGRAM function starts, and the channels received are registered in the channel list (PR list) automatically.

3 "SETUP TOUR RESTART?" appears.

To start the SETUP TOUR	Press the MENU/OK button. Then proceed to step 5 of "Setting up your TV" on page 7.
-------------------------	-------------------------------------------------------------------------------------

To skip the SETUP TOUR	Press the Red button.
------------------------	-----------------------

4 The EDIT menu appears.

To edit the channel list	Proceed to the Step 3 of "To edit the channel list (PR list)" on this page.
--------------------------	-----------------------------------------------------------------------------

If a channel is not registered	Proceed to the Step 3 of "To register the channel manually" on this page.
--------------------------------	---------------------------------------------------------------------------

To exit the menu	Press the MENU/OK button.
------------------	---------------------------

For details of "SETUP TOUR", see page 7.

To register the TV channels manually (MANUAL in the EDIT menu)

You can register the TV channels into the TV's channel list manually.

1 Display the INSTALL menu.

* [MENU] → [INSTALL]

2 Choose EDIT/ MANUAL, then press the MENU/OK button. EDIT menu appears.

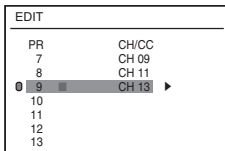

3 Choose the channel which you want to register.

4 Press the blue button to activate the MANUAL function.

The sound system of the channel appears at the right of the CH/CC number.

5 Press the 3 button to choose an appropriate sound system.

For details, see "SOUND SYSTEM" on page 10.

6 Press the green or red button to search for the TV channel.

Searching stops when a channel is found and displayed.

7 Repeat step 5 until your desired TV channel appears.

If the reception is poor	Press the blue or yellow button to fine tune the TV channel.
--------------------------	--------------------------------------------------------------

If noisy sound is heard	Press the ► button to choose an appropriate sound system.
-------------------------	-----------------------------------------------------------

8 Press the MENU/OK button to exit the menu.

To edit the channel list (PR LIST) (MOVE and DELETE in the EDIT menu)

You can edit the TV channel list as you like.

Note: After this operation, other channel's PR numbers will be changed.

1 Display the INSTALL menu.

* [MENU] → [INSTALL]

2 Choose EDIT/ MANUAL, then press the MENU/OK button. EDIT menu appears.

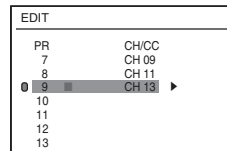

3 Choose the channel which you want to change PR number, or delete.

4 Do the following action:

To change the PR number (MOVE)	Press the ► button. Then move it to the PR number you want to use it for the channel. Finally press the ◀ button.
--------------------------------	-------------------------------------------------------------------------------------------------------------------

To delete the channel (DELETE)	Press the yellow button.
--------------------------------	--------------------------

5 Press the MENU/OK button to exit the menu.

* About the basic operations of the menu, please see the "How to operate menus and menu locations" on page 4.

TV channel presetting

To add in the new channel (INSERT in the EDIT menu)

You can add in the new channel in the TV channel list as you like.
 You need to find the “CH/CC” number for the TV channel. Find the “CH/CC” number corresponding to the channel number of the TV channel from the attached sheet “CH/CC number list” on this page.

- 1 Display the INSTALL menu.
 * **MENU** → **INSTALL**
- 2 Choose EDIT/ MANUAL, then press the MENU/OK button. EDIT menu appears.
- 3 Choose the PR number for which you will register a new TV channel. When you add a new TV channel of NTSC-M system, press the SOUND SYSTEM button to change the sound system to M. Then proceed to the next step.
- 4 Press the green button, then press ▲/▼ buttons to choose “CC” or “CH”.
- 5 Press the number button to enter the remaining CH/CC number.

The TV starts to search the TV channel, and the picture of the TV channel appears. If the TV finds no TV channel, a noisy picture appears.

When a TV channel has already been registered in PR99, using the INSERT function deletes that TV channel.

* About the basic operations of the menu, please see the “How to operate menus and menu locations” on page 4.

CH/CC number

When you want to use the INSERT function by the previous operation, find the CH/CC number corresponding to the channel number of the TV channel from this table.

Channel No.	Country
US	United States, Philippines, etc..
CCIR	Middle East, Southeast Asia, etc..
OIRT	Eastern Europe, Russia, Vietnam, etc..
AUSTRALIA	Australia, etc..

Channel

CH	US	CCIR	OIRT	AUSTRALIA	CH	US	CCIR	OIRT	AUSTRALIA
CH 02	US-2	E2	R1	AU-0	CH 36	US-36, W+ 51	E36		
CH 03	US-3	E3		AU-1	CH 37	US-37, W+ 52	E37		
CH 04	US-4	E4	R2	AU-2	CH 38	US-38, W+ 53	E38		
CH 05	US-5	E5	R6	AU-6	CH 39	US-39, W+ 54	E39		
CH 06	US-6	E6	R7	AU-7	CH 40	US-40, W+ 55	E40		
CH 07	US-7	E7	R8	AU-8	CH 41	US-41, W+ 56	E41		
CH 08	US-8	E8	R9	AU-9	CH 42	US-42, W+ 57	E42		
CH 09	US-9	E9			CH 43	US-43, W+ 58	E43		
CH 10	US-10	E10	R10	AU-10	CH 44	US-44, W+ 59	E44		
CH 11	US-11	E11	R11	AU-11	CH 45	US-45, W+ 60	E45		
CH 12	US-12	E12	R12		CH 46	US-46, W+ 61	E46		
CH 13	US-13				CH 47	US-47, W+ 62	E47		
CH 14	US-14, W+ 29				CH 48	US-48, W+ 63	E48		
CH 15	US-15, W+ 30				CH 49	US-49, W+ 64	E49		
CH 16	US-16, W+ 31				CH 50	US-50, W+ 65	E50		
CH 17	US-17, W+ 32				CH 51	US-51, W+ 66	E51		
CH 18	US-18, W+ 33				CH 52	US-52, W+ 67	E52		
CH 19	US-19, W+ 34				CH 53	US-53, W+ 68	E53		
CH 20	US-20, W+ 35				CH 54	US-54, W+ 69	E54		
CH 21	US-21, W+ 36	E21			CH 55	US-55, W+ 70	E55		
CH 22	US-22, W+ 37	E22			CH 56	US-56, W+ 71	E56		
CH 23	US-23, W+ 38	E23			CH 57	US-57, W+ 72	E57		
CH 24	US-24, W+ 39	E24			CH 58	US-58, W+ 73	E58		
CH 25	US-25, W+ 40	E25			CH 59	US-59, W+ 74	E59		
CH 26	US-26, W+ 41	E26			CH 60	US-60, W+ 75	E60		
CH 27	US-27, W+ 42	E27			CH 61	US-61, W+ 76	E61		
CH 28	US-28, W+ 43	E28			CH 62	US-62, W+ 77	E62		
CH 29	US-29, W+ 44	E29			CH 63	US-63, W+ 78	E63		
CH 30	US-30, W+ 45	E30			CH 64	US-64, W+ 79	E64		
CH 31	US-31, W+ 46	E31			CH 65	US-65, W+ 80	E65		
CH 32	US-32, W+ 47	E32			CH 66	US-66, W+ 81	E66		
CH 33	US-33, W+ 48	E33			CH 67	US-67, W+ 82	E67		
CH 34	US-34, W+ 49	E34			CH 68	US-68, W+ 83	E68		
CH 35	US-35, W+ 50	E35			CH 69	US-69, W+ 84	E69		

CC	US	CCIR	OIRT	AUSTRALIA	CC	US	CCIR	OIRT	AUSTRALIA
CC 01		S-1		AU-5	CC 38	W+ 2	S-38		
CC 02		S-2			CC 39	W+ 3	S-39		
CC 03		S-3			CC 40	W+ 4	S-40		
CC 04		S-4			CC 41	W+ 5	S-41		
CC 05		S-5			CC42	W+ 6			
CC 06		S-6		AU-5A	CC 43	W+ 7			
CC 07		S-7			CC 44	W+ 8			
CC 08		S-8			CC 45	W+ 9			
CC 09		S-9			CC 46	W+ 10			
CC 10		S-10			CC 47	W+ 11			
CC 11		S-11			CC 48	W+ 12			
CC 12		S-12			CC 49	W+ 13			
CC 13		S-13			CC 50	W+ 14			
CC 14	A	S-14			CC 51	W+ 15			
CC 15	B	S-15			CC 52	W+ 16			
CC 16	C	S-16			CC 53	W+ 17			
CC 17	D	S-17			CC 54	W+ 18			
CC 18	E	S-18			CC 55	W+ 19			
CC 19	F	S-19			CC 56	W+ 20			
CC 20	G	S-20			CC 57	W+ 21			
CC 21	H	S-21			CC 58	W+ 22			
CC 22	I	S-22			CC 59	W+ 23			
CC 23	J	S-23			CC 60	W+ 24			
CC 24	K	S-24			CC 61	W+ 25			
CC 25	L	S-25			CC 62	W+ 26			
CC 26	M	S-26			CC 63	W+ 27			
CC 27	N	S-27			CC 64	W+ 28			
CC 28	O	S-28			CC 75		X		
CC 29	P	S-29			CC 76		Y	R3	
CC 30	Q	S-30			CC 77		Z	R4	AU-3
CC 31	R	S-31			C 78		Z+ 1	R5	
CC 32	S	S-32			CC 79		Z+ 2		AU-4
CC 33	T	S-33			CC 95	A-5			
CC 34	U	S-34			CC 96	A-4			
CC 35	V	S-35			CC 97	A-3			
CC 36	W	S-36			CC 98	A-2			
CC 37	W+ 1	S-37			CC 99	A-1			

Additional preparation

The illustrations shown in this section are for AV-14FMG4 only, which are used for explanation purpose. Your TV may not look exactly the same as illustrated.

Before connecting

- Read the manuals provided with the devices for the proper connection.
- Turn off all the devices including the TV.
- Note that connecting cables are not supplied.

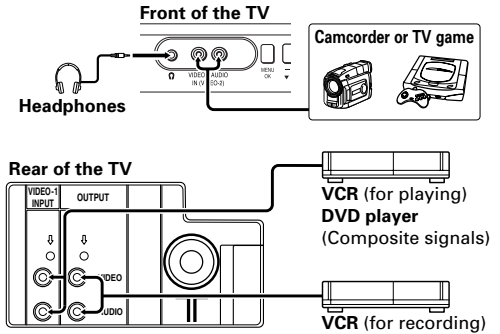

Troubleshooting

If a problem occurs when you are using the TV, check the following troubleshooting guide before calling for repair.

No picture, no sound	<ul style="list-style-type: none"> • Deactivate the BLUE BACK function if it is turned on. • Choose the appropriate sound system. Refer to "SOUND SYSTEM" on page 10. 	Cannot operate the remote control	<ul style="list-style-type: none"> • The batteries may be exhausted. Replace with new batteries (see page 6). • Ensure that you are operating the remote less than seven meters from the front of your TV.
Snowy picture	<ul style="list-style-type: none"> • Check the aerial cable and its connection with the TV. 	Cannot operate the TV menus	<ul style="list-style-type: none"> • Press TV/VIDEO button to return to TV mode and try operating the menus.
Stripes appear on the picture	<ul style="list-style-type: none"> • Interference occurs caused by other devices such as an amplifier, personal computer, or a hair drier. Move such devices away from your TV. 	Cannot operate the front control buttons	<ul style="list-style-type: none"> • Deactivate the CHILD LOCK function if it is turned on (see page 12).
Double-pictures (ghosting) occur	<ul style="list-style-type: none"> • Interference occurs caused by signal reflecting from mountains or building. Try to adjust the aerial's direction or use a better directionality antenna. 	TV is turned off suddenly	<ul style="list-style-type: none"> • This may due to the AUTO SHUT OFF function is activated. Press the POWER button to turn on the TV.
Poor picture	<ul style="list-style-type: none"> • Choose the appropriate colour system. Refer to "COLOUR SYSTEM" on page 8. • Adjust the COLOUR or BRIGHT setting. Refer to "Adjusting the picture - USER" on page 8. 	Colour patches appear at the corner of the screen	<ul style="list-style-type: none"> • This may due to the magnetized device such as a speaker near to your TV. Keep the device apart from your TV. Alternately, you can also use the magnetic- shielded speaker.
White and bright still image look as if it were coloured	<ul style="list-style-type: none"> • Inevitable phenomenon due to the nature of the picture tube. This is not a malfunction. 	Image takes a short period to be displayed	<ul style="list-style-type: none"> • Image required time to stabilize before display. This is not a malfunction.
Top of the image from software products or video tape is distorted	<ul style="list-style-type: none"> • This is due to the condition of the video signal whereby the image was not recorded properly. This is not a malfunction. 	TV may emitted crackling sound	<ul style="list-style-type: none"> • This is due to a sudden change in temperature and it is not a malfunction. If the crackling sound is too frequent, request your service technician for inspection.
		Feel a slight electric shock when touching the TV screen	<ul style="list-style-type: none"> • This is due to the static electricity of the picture tube and it will not harm the human body. This is not a malfunction.

Specifications

TV RF systems

B/G, I, D/K, M

Colour systems

PAL, SECAM, NTSC 3.58 MHz, NTSC 4.43 MHz

Receiving channels

VHF low channel (VL), VHF high channel (VH), UHF channel (U)

Receives cable channels in mid band, super band and hyper band.

Power requirements

AC 110 to 240 V, 50/60 Hz

External input / output

VIDEO-1: VIDEO input, AUDIO input

VIDEO-2: VIDEO input, AUDIO input,

OUTPUT: VIDEO output, AUDIO output

Headphone jack: stereo mini jack (3.5 mm diameter,
sound is monaural)

Teletext system < AV-14FMT4/AV-21CMT4/AV-21DMT4/AV-21YMT4 only >

FLOF (Fasttext), WST (World Standard Text)

Language displayed by teletext < AV-14FMT4/AV-21CMT4/AAV-21DMT4/V-21YMT4 only >

Please see the table in the description "TEXT LANGUAGE" on page 9.

Design and specifications are subject to change without notice.

JVC